

Fig 1

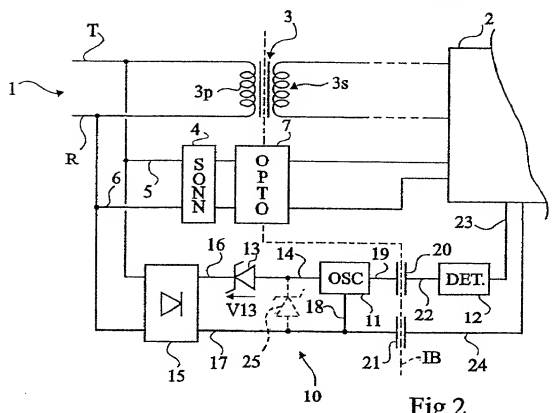

Fig 2

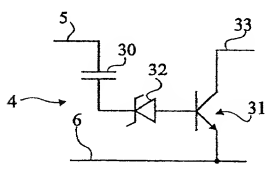
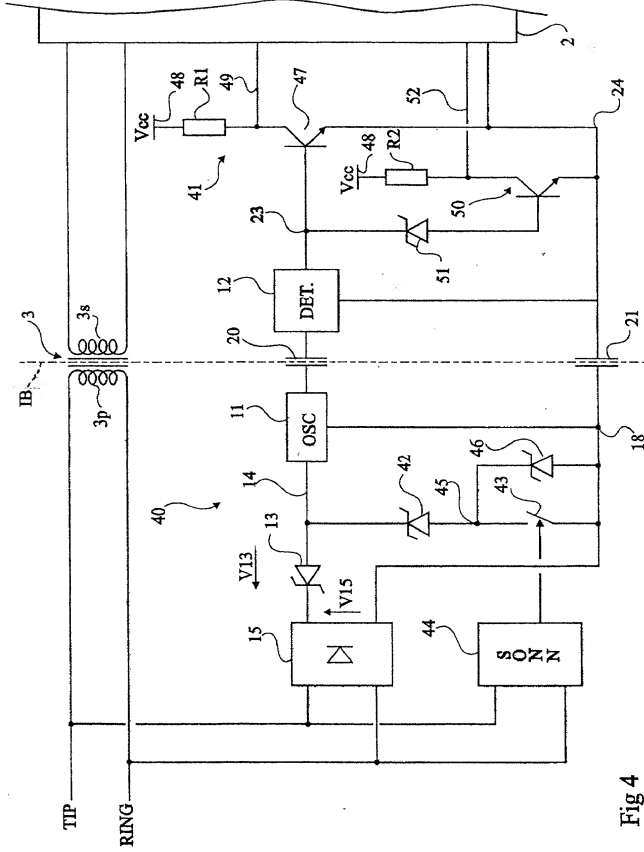

Fig 3

2025 RELEASE UNDER E.O. 14176



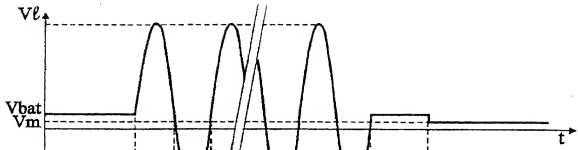

Fig 5A

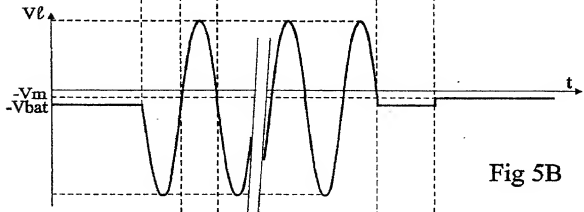

Fig 5B

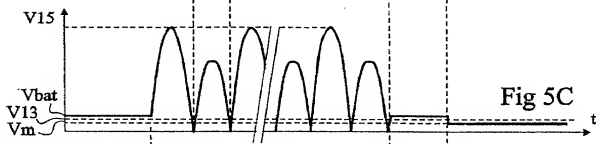

Fig 5C

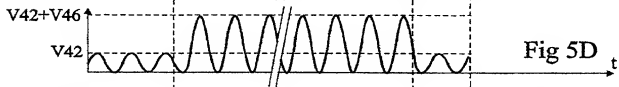

Fig 5D

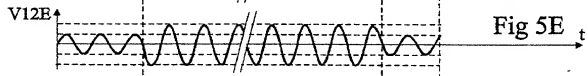

Fig 5E

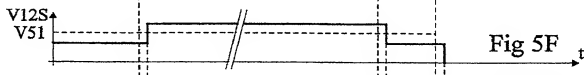

Fig 5F

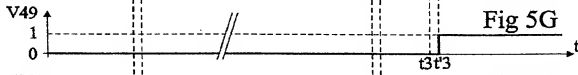

Fig 5G

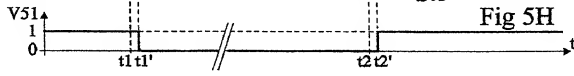

Fig 5H

$t_1 t_1'$ // $t_2 t_2'$ $t_3 t_3'$

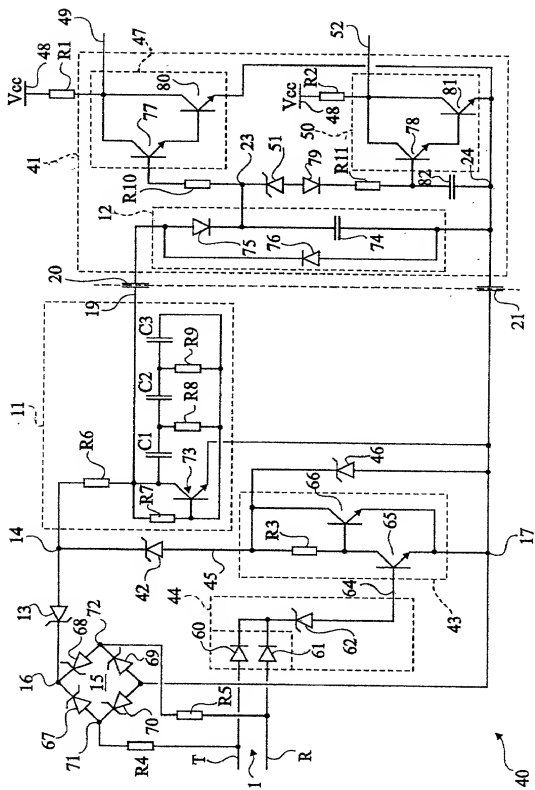

Fig 6